



USER INSTRUCTIONS

- H20- Axon Harness Regular
- H20Q - Axon Harness Quick Connect
- H20L - Axon Harness Large
- H20QL- Axon Harness Quick Connect Legs Large

**Attachment points**

Only points marked "A" in the diagram and on the harness may be used for fall arrest. The ring marked "B" is the main work positioning attachment point. Those marked "C" should be used simultaneously for the attachment of work positioning lanyards

**MAKE SURE YOU USE THE CORRECT ATTACHMENT POINT FOR THE CORRECT PURPOSE.**

Ropes and rope lanyards may be tied directly to attachment points; otherwise, ensure that suitable locking connectors are used and correctly fastened. A screwlink connector is recommended. Check that connectors are securely closed during use. Incorrect combinations of connectors may accidentally detach from one another by a process known as "roll-out". The harness should be connected to an anchor point via an appropriate system which ideally should conform to the relevant EN standard. In fall arrest, this system must limit the forces on the body in the event of a fall.

**Checking your harness**

Check fit whilst suspended in a safe location - the harness should feel secure but not too tight. Check for twisted straps. Check buckles are secure by pulling on loaded webbing - correctly threaded buckles will lock. Fastening and adjustment elements should also be checked regularly during use.

**Attaching a Twist chest ascender**

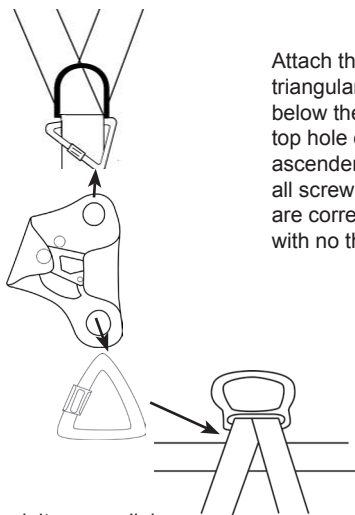

Attach the small triangular screwlink just below the D-ring to the top hole of the chest ascender. Make sure all screwlink connectors are correctly fastened with no thread visible.

Use an 8mm delta screw link connector to attach the lower hole of the chest ascender in to the webbing loop behind the central D-ring.

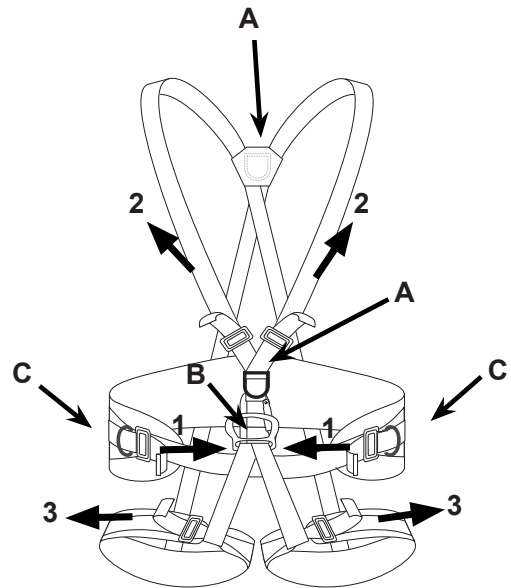

Step into harness, fasten and adjust in the order 1 - 2 - 3 in the diagram. If necessary the rear D-ring may be adjusted up and down by sliding the webbing through the buckle arrangement.

Shoulder straps may be completely unfastened by releasing the connector at the front and passing the shoulder straps over the head. Once the harness is fitted, ensure the connector is correctly fastened to the loop behind the main work positioning attachment point "B".

**Fastening**

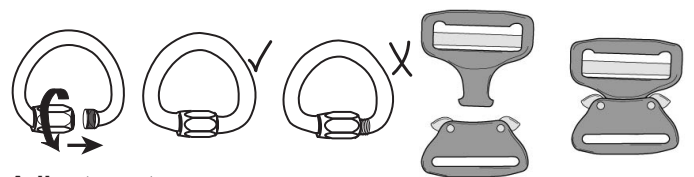

**Adjustment**

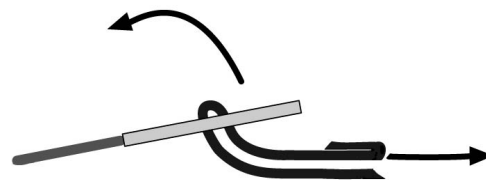

Slack ends of webbing may be tucked into elastic loops to keep them out of the way.

Harnesses are made from polyamide and polyester, with steel and aluminium alloy fittings. Materials are not significantly affected by temperatures in the range -30 to +80 degrees Celsius.

**Warnings**

Do not use this product outside its limitations, or for any purpose other than that recommended above. Do not alter or make additions to this product.  
 Fall arrest: only a full body harness is acceptable for use in fall arrest.  
 Work positioning: a secondary means of protection may be necessary e.g. safety nets or a fall arrest system to EN363.  
 All harnesses are suitable for a person weighing up to 125kg. Ensure that any other equipment is suitable for the weight of user.

**1 - Personal issue and traceability:**

This product is personal protective equipment and should be individually issued to the person who will be using it. The product should remain traceable to the original certificate of conformity and a permanent record should be kept of its use. This user instruction forms part of the permanent product record. All users must receive and read a copy of these instructions and should understand what the instructions mean and be familiar with them, including, but not limited to function, suitability, compatibility of the product and inspection for defects arising from damage. A copy of this user instruction should be kept with the equipment, and referred to before and after each use. In the event of a rescue, these instructions should be provided to the rescuer.

**2a - Anchor Points:**

The anchor device or anchor point used should be of sufficient strength to sustain foreseeable loads in all permitted directions. Specific standards requirements:  
EN: Anchor device should conform to EN795, with minimum static strength of 12kN. heightec recommend a higher strength of 15kN as specified in the IRATA ICOP and BS7985.  
When more than one system is attached to an anchorage, these strengths should be multiplied by the number of systems.  
Anchorages should be positioned to minimise the potential for falls, and the distance and consequences of any potential fall, ideally above above the user. Verify there is sufficient free space beneath the user to avoid collision with the ground or other obstacles and minimise sideways or pendulum falls. The connecting system instructions should give advice on clearance required, but a fall arrest energy absorber may extend by up to 1.75m.

**2b - Further Requirements for Anchor Points in US (ANSI):**

ANSI: (a) where certified, twice the maximum arrest force, or (b) where not certified 22.2kN (5,000lbf) for fall arrest, 13.3kN (3,000lbf) for work positioning, or 4.5kN (1,000lbf) for restraint. When designing, selecting, and certifying a fall arrest anchorage, the qualified person shall include the limitations on use of the system in fall protection procedures described in ANSI Z359.2. Design, selection and installation of certified fall arrest anchorages shall include determining a safe location where and how to connect those anchorages by taking into consideration the forces generated by arresting a fall, total existing and anticipated loading, load path, structural member strengths, connection and support strengths, stability, clearance requirements, swing fall, rescue deflection of the system, and impact on the structural members to which the fall arrest system is attached.  
Anchorages selected for rescue systems shall have a strength capable of sustaining static loads, applied in the directions permitted by the rescue system of at least 3,100lbf for connection of rescue system only, or meet a Factor of Safety of 5:1 based on the static load placed on the system when the system is designed, installed and used under the supervision of a qualified person.

Persons engaged in rescue operations that are exposed to a fall hazard, must be provided an anchorage suitable for fall arrest in accordance with ANSI Z359.1.

Anchorage connectors shall not be attached to anchorages where such attachment would reduce the anchorage system strength below the applicable level set forth above or reduce the anchorage strength below the allowable level set by applicable structural codes. A suitable anchorage connector shall be used for rigging the connection of lanyards and lifelines to structural members. A lanyard shall not be connected back onto itself for use as an anchorage connector unless specifically designed for this purpose.

Anchorage connections shall be stabilised to prevent unwanted movement or disengagement of the rescue system from the anchorage. Verify system connections by pre-tensioning the system before applying the intended load.

Other components used in fall protection or work positioning systems must conform to the relevant standards, be compatible with each other and be used in accordance with their user instructions.

**3a - Inspection and care:**

The strength of this product may be affected by cuts, nicks, deep scratches, wear, abrasion, deformation, chemical contamination, UV degradation, exposure to flame, extreme temperatures and other factors. Keep this equipment away from such sources of damage. Use this product with caution near moving machinery, electrical hazards, sharp edges and abrasive surfaces.

This product must be inspected before and after use, and particularly after being used for rescue, to ensure the product is in a suitable condition and operates correctly. Written records should be kept of all inspections.

If there is any doubt about condition of the product, or it has been subjected to a fall or substantial shock load, withdraw it from use until confirmed to be safe, in writing, by a person deemed to be competent by The heightec Group.

No repairs of this product should be undertaken, any attempt to do so may invalidate it's compliance and/ or certification.

The safety of users depends upon the continued efficiency and durability of this equipment, which must subjected to detailed visual and tactile examination by a competent person\* at intervals of no greater than 6 months for textiles or 12 months for metals, taking into account relevant legislation, equipment type, frequency of use and environmental conditions. These examinations should be carried out strictly in accordance with the manufacturer's periodic examination procedures. Detailed examinations should include confirmation of the legibility of product markings.

\*A competent person may be defined as someone who "...has appropriate theoretical and practical knowledge and experience..."

The results of examinations should be recorded. Intermittent inspections of components which may be subject to excessive wear may also be appropriate. The results of these need not be recorded. Contact your distributor for information on suitable inspection procedures.

**3b - Inspection criteria:**

Textile products or elements: check material and stitching for damage including cuts, nicks, abrasion, fraying, discolouration, heat or chemical damage etc. Ensure stoppers are present on ends of adjustment webbing.

Metal devices or components: check for damage, corrosion, excessive tightness, sharp edges, excessive play, deformation, cracking or anything that might affect strength. Check security and correct operation of any moving parts e.g. side plates, return action of springs, cams, operating handles, bearings. Check function of closure mechanisms, where present (e.g. screwlink thread, connector gates).

**3c - Cleaning, maintenance and storage:**

Wash textiles by hand with non-detergent soap at approx 25°C (cool). Rinse and dry naturally, away from direct sources of heat and sunlight. If necessary use a disinfectant compatible with polyamide and polyester. Use diluted and rinse thoroughly in clean water. Dry as previously stated. These cleaning procedures must be strictly adhered to.

Mechanical metal products with moving parts should be occasionally oiled, at bearings or pivot points, with excess oil removed. Store and transport in a dry, clean condition, away from sources of severe vibration, humidity, direct heat, sunlight and any physical or chemical contaminants.

**4 - Lifespan:**

Textile products or elements: maximum 10 year lifespan from date of manufacture, subject to competent use, maintenance and examination programme.

Helmets: 5 years from first use plus up to 5 years storage subject to competent use, maintenance and examination program.

Metal products: indefinite lifespan, subject to competent use, care and examination programme. The lifespan of all products will be reduced by normal wear and tear, particularly when used in abrasive or corrosive environments. In extreme circumstances, the life of an item may be reduced to a single use.

**5a - General usage:**

Users should be suitably trained and competent to work in situations where a risk of falling may be present or under the direct supervision of such a person, fully trained in the use of this product and free of medical contra-indications for work at height or rescue. Do not use this product outside of its limitations or if you are unsure of any aspect of its use. No alterations or additions may be made to the product. The heightec Group do not take any responsibility for injury or accident of any kind arising from the use of this product.

INSPECTION RECORDS		ID Number:			
Product:		PO/ Certificate No.:			
Model/Type:		Purchase Date:			
Manufacture Date:		First Use Date:			
Date	Observations / Comments	Actions	Inspector	Next Due	

It is essential a rescue plan is in place to deal with emergencies and in particular to consider treatment and recovery of a fallen or suspended person. Rescue equipment must be present and personnel should be competent in its use. Orthostatic intolerance can occur when a person is suspended motionless in a harness, and is potentially fatal. Ensure that the rescue of a suspended person is carried-out promptly. Contamination with oils, lubricants, water or solvents may alter the performance of the product. For rope devices behaviour will vary according to the age, type, diameter and characteristics of the rope used.

**5b - Care of rope during use:**

Take any steps necessary to protect the rope from damage during use, including rope protectors, edge protectors, intermediate anchor points or deviations to avoid sharp or rough edges. Consider also the position of the rope below the user. Ensure rope cannot suffer from the effects of wind, or become trapped around obstacles.

**6 - Guarantee:**

This product is guaranteed for three years against faults arising from manufacturing errors or materials defects. This guarantee does not include normal wear and tear, faults arising from uses for which the product was not designed and accidental damage.

**7 - Notes:**

If this product is re-sold outside the original country of destination the reseller shall provide these instructions in the language of the country in which the product is to be used.

Markings:

The following markings may be present on the product:

 CE mark - European Conformity.

 Read these instructions before use.

 For use with kernmantel ropes conforming to EN1891 type A

 XX-YY - Diameter range of rope which this product may be used, in mm

 Direction of use

Date of manufacture is marked on the product in the form: DAY MONTH YEAR, DDMMYY eg.120510.

The ID no. is unique to this item. Do not remove or obscure the product labels or markings. Unique ID should be read in conjunction with product code and batch number e.g. D01 120510 123